

TUSCAN POST MOUNT



INSTALLATION INSTRUCTIONS

Step 1 Safety Precautions

Review all local building codes.
Wear proper safety equipment.

Step 2 Prepare Mounting Surfaces

Determine placement of post on deck surface.
Set post in place and mark mounting holes.

Step 3 Mount Post

(See illustrations for mounting options.) Mount post to deck surface using one of the options and suggested mounting hardware listed in Mounting Options. **INSTALLER MUST DETERMINE THE PROPER MOUNTING HARDWARE (NOT INCLUDED).**

With Post secured to deck surface, check post with a level. If the post needs to be adjusted for plumb, loosen mounting bolts and adjust with included 1/4" shims. **(See Using Shims)** INCLUDED SHIMS ALLOW APPROXIMATELY 4-5° MAXIMUM PLUMB CORRECTION.

Step 4 Adjust Top Block Height (optional)

When using 42" high railing, it is necessary to adjust top block height. To adjust height, remove lock screw, remove and rotate top block, reinstall block, then reinstall lock screw. **(See illustrations for adjusting top block height)** **MAKE CERTAIN SCREW IS TIGHT ON TOP BLOCK.**

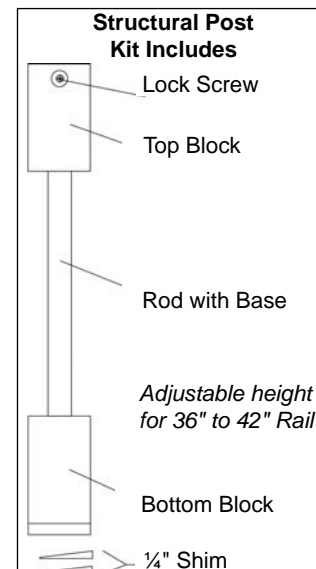
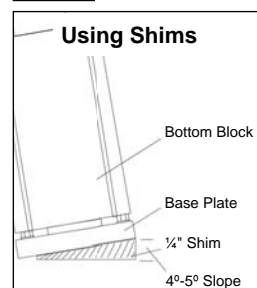
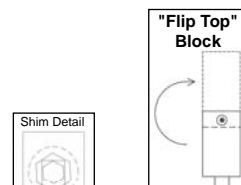

Mounting Options

Wood Surfaces

All-Thread Bolts

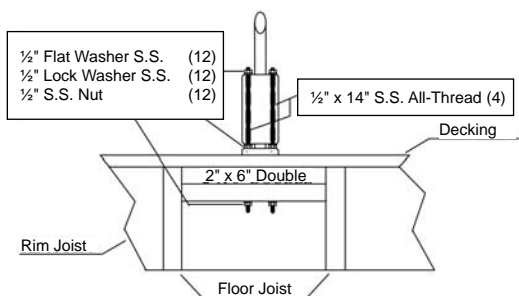

Carriage Bolts

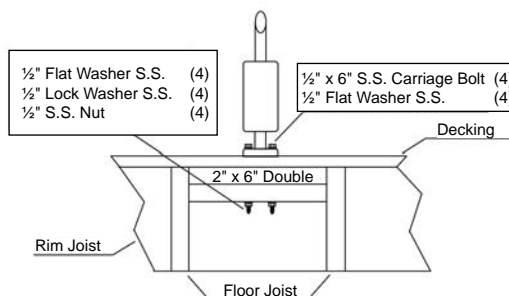

Concrete Surfaces

All-Thread Bolts

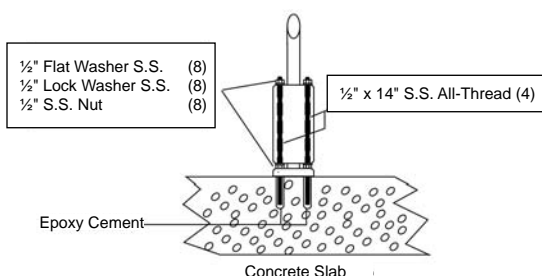

Masonry Bolts

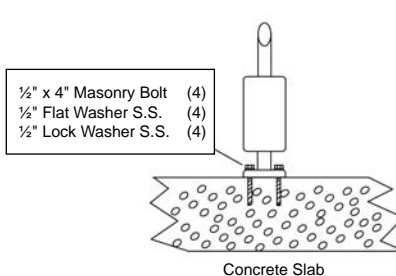

Adjusting Top Block Height

